

Drop-In Drop-in remote refrigerated well, ventilated (3 GN container capacity)

ITEM # _____

MODEL # _____

NAME # _____

SIS # _____

AIA # _____

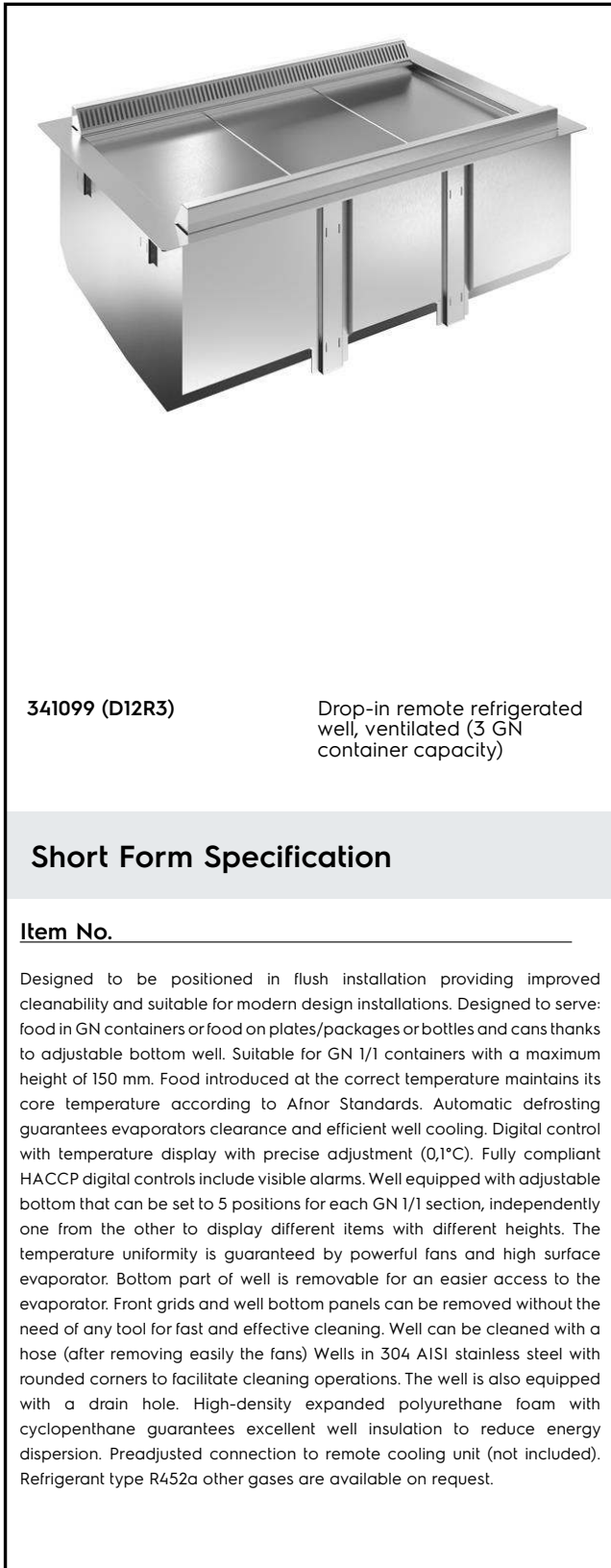
341099 (D12R3)

Drop-in remote refrigerated well, ventilated (3 GN container capacity)

Short Form Specification

Item No.

Designed to be positioned in flush installation providing improved cleanability and suitable for modern design installations. Designed to serve: food in GN containers or food on plates/packages or bottles and cans thanks to adjustable bottom well. Suitable for GN 1/1 containers with a maximum height of 150 mm. Food introduced at the correct temperature maintains its core temperature according to Afnor Standards. Automatic defrosting guarantees evaporators clearance and efficient well cooling. Digital control with temperature display with precise adjustment (0,1°C). Fully compliant HACCP digital controls include visible alarms. Well equipped with adjustable bottom that can be set to 5 positions for each GN 1/1 section, independently one from the other to display different items with different heights. The temperature uniformity is guaranteed by powerful fans and high surface evaporator. Bottom part of well is removable for an easier access to the evaporator. Front grids and well bottom panels can be removed without the need of any tool for fast and effective cleaning. Well can be cleaned with a hose (after removing easily the fans) Wells in 304 AISI stainless steel with rounded corners to facilitate cleaning operations. The well is also equipped with a drain hole. High-density expanded polyurethane foam with cyclopentane guarantees excellent well insulation to reduce energy dispersion. Preadjusted connection to remote cooling unit (not included). Refrigerant type R452a other gases are available on request.

Main Features

- Bottom part of well is removable for an easier access to the evaporator.
- Preadjusted connection to remote cooling unit (not included).
- Suitable for GN 1/1 containers with a maximum height of 150 mm.
- CB and CE certified by a third party notified body.
- Designed to be positioned in flush installation providing improved cleanability and suitable for modern design installations.
- Precise temperature control and setting at 0,1°C .
- As standard the product comes with digitally controlled thermostat which is in line of HACCP norms and provides visual alarm as a warning of the increasing or decreasing temperatures.
- Food introduced at the correct temperature maintains its core temperature according to Afnor Standards.
- Automatic defrosting guarantees evaporators clearance and efficient well cooling.
- Designed to serve: food in GN containers or food on plates/packages or bottles and cans thanks to adjustable bottom well.
- Available drop-in dimensions: 2, 3, 4, 5 GN.
- Well equipped with adjustable bottom that can be set to 5 positions for each GN 1/1 section, independently one from the other to display different items with different heights.
- The temperature uniformity is guaranteed by powerful fans and high surface evaporator.
- Front grids and well bottom panels can be removed without the need of any tool for fast and effective cleaning.
- Well can be cleaned with a hose (after removing easily the fans).
- Built-in cooling unit version is available.

Construction

- Well bottom is inclined to facilitate water drainage.
- Well in 304 AISI stainless steel with rounded corners to facilitate cleaning operations. The well is also equipped with a drain hole.
- Electronic control with temperature display.
- IPx2 water protection.

Sustainability

- High-density expanded polyurethane foam with cyclopentane guarantees excellent well insulation to reduce energy dispersion.



APPROVAL: _____

Rear side

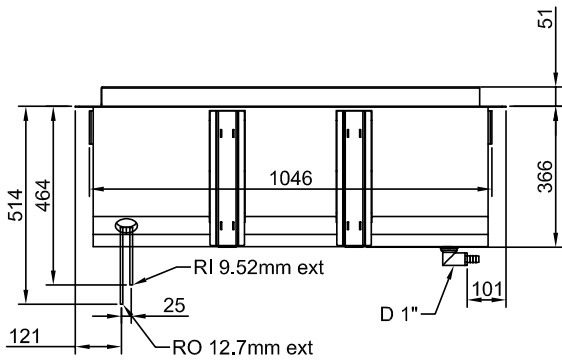

Side

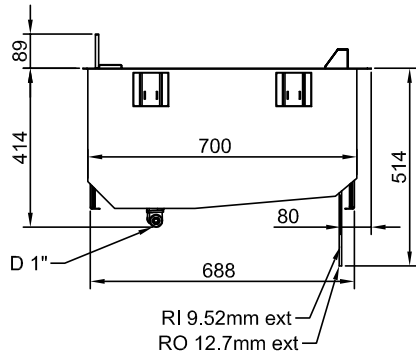

- D = Drain
- EI = Electrical inlet (power)
- RI = Refrigerant Inlet

Top

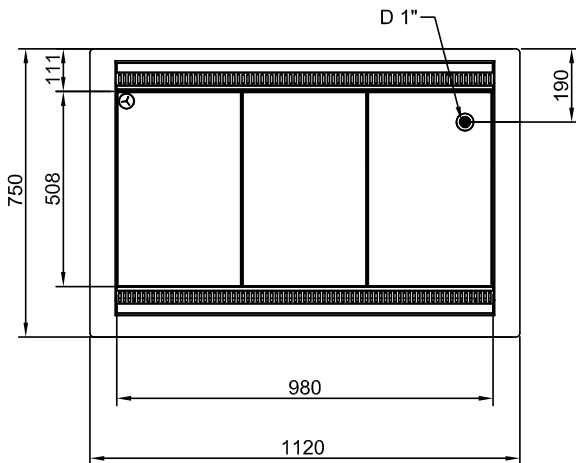

Electric

Supply voltage: 220-240 V/1N ph/50 Hz
Electrical power, max: 0.07 kW

Water:

Water drain outlet size: 1"

Key Information:

External dimensions,
Width: 1120 mm
External dimensions,
Depth: 750 mm
External dimensions,
Height: 390 mm
Net weight: 49.7 kg
Shipping weight: 67 kg
Shipping height: 900 mm
Shipping width: 800 mm
Shipping depth: 1160 mm
Shipping volume: 0.84 m³
Set temperature: +4 / +8 °C

Refrigeration Data

Refrigerant type: R452A
Connection pipes (remote)
- outlet: 12.7 mm
Connection pipes (remote)
- inlet: 9.52 mm

Sustainability

Noise level: 0 dBA



Front view
Scala: 1:10



Dettaglio D
Scala 1:7



Section Cut A-A
Scala: 1:10



Dettaglio B
Scala 1:2



Top view
Scala: 1:10

CAPACITY	CUTOUT		LOWERING FOR FLUSH INSTALLATION		C
	A1	B1	A2	B2	
2GN	740	710	804	754	920
3GN	1060		1124		1250
4GN	1390		1454		1580
5GN	1710		1774		1900



595T02400 - COLD VENT. WELL REM.